

Hybrid Stepper Motor 86BYGH450B-04

Mechanical Dimensions:

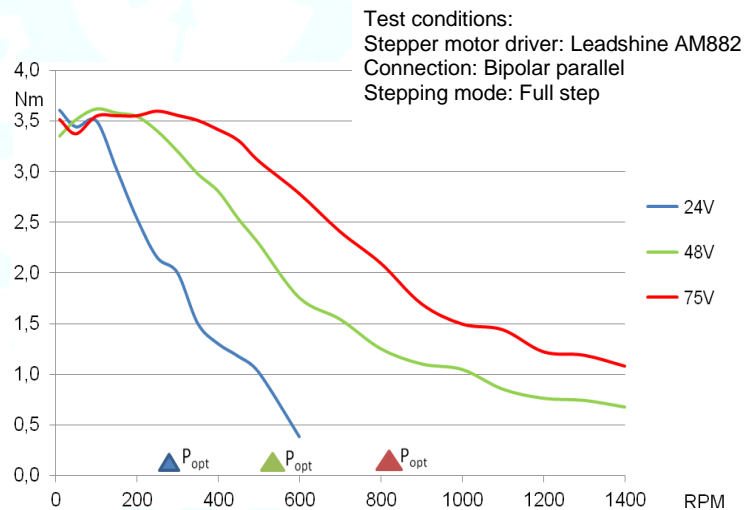
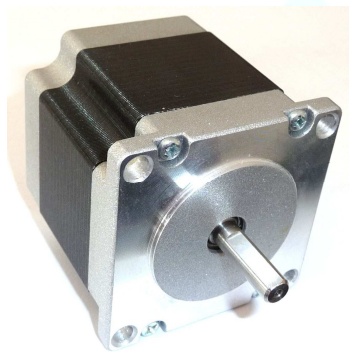
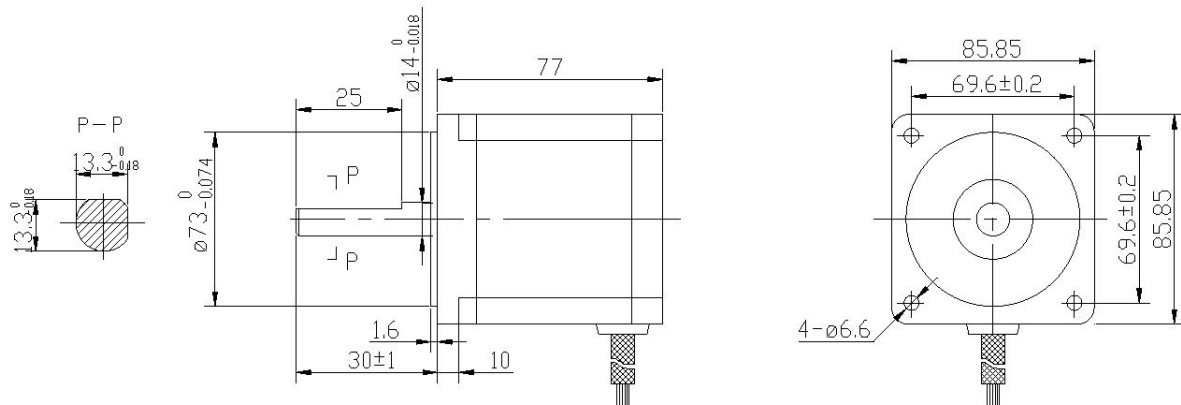

Electrical Specifications:

	Unipolar	Bipolar Serial	Bipolar Parallel
No. of phases	4	2	2
Step Angle	1.8 ± 0.09°		
Rated Voltage (V)	3.2	4.5	2.3
Current (A)	4.2	3.0	5.9
Resistance (Ω)	0.75	1.5	0.38
Inductance (mH)	3.5	14	3.5
Holding Torque coils on DC (Nm)	3.9	5.5	5.5
Holding Torque step mode (Nm)	2.8	3.9	3.9
Rotor Inertia (kgcm ²)	1.7		
Insulation Class	B		
Insulation Resistance	100MΩ. 500VDC		
Weight (kg)	2.2		