

User's Manual

For

DM442

Fully Digital Stepping Drive

Version 1.0

©2010 All Rights Reserved

Attention: Please read this manual carefully before using the drive!



The content in this manual has been carefully prepared and is believed to be accurate, but no responsibility is assumed for inaccuracies.

Leadshine reserves the right to make changes without further notice to any products herein to improve reliability, function or design. Leadshine does not assume any liability arising out of the application or use of any product or circuit described herein; neither does it convey any license under its patent rights of others.

Leadshine's general policy does not recommend the use of its products in life support or aircraft applications wherein a failure or malfunction of the product may directly threaten life or injury. According to Leadshine's terms and conditions of sales, the user of Leadshine's products in life support or aircraft applications assumes all risks of such use and indemnifies Leadshine against all damages.



Leadshine Technology Co., Ltd.

©2010 by Leadshine Technology Company Limited.
All Rights Reserved

Table of Contents

1. Introduction, Features and Applications	1
Introduction	1
Features	1
Applications	1
2. Specifications	2
Electrical Specifications	2
Mechanical Specifications.....	2
Elimination of Heat	2
Operating Environment and other Specifications.....	3
3. Pin Assignment and Description	3
Connector P1 Configurations	3
Selecting Active Pulse Edge and Control Signal Mode	4
Connector P2 Configurations	4
4. Control Signal Connector (P1) Interface.....	4
5. Connecting the Motor.....	5
Connections to 4-lead Motors	5
Connections to 6-lead Motors	5
Half Coil Configurations	5
Full Coil Configurations.....	6
Connections to 8-lead Motors	6
Series Connections	6
Parallel Connections.....	7
6. Power Supply Selection	7
Regulated or Unregulated Power Supply	7
Multiple Drives	8
Selecting Supply Voltage.....	8
7. Selecting Microstep Resolution and Drive Output Current.....	8
Microstep Resolution Selection	8
Current Settings.....	9

Dynamic current setting	10
Standstill current setting	10
8. Wiring Notes	10
9. Typical Connection.....	11
10. Sequence Chart of Control Signals	11
11. Protection Functions	12
Over-current Protection	12
Over-voltage Protection	12
Phase Error Protection.....	12
Protection Indications.....	13
12. Frequently Asked Questions.....	13
Problem Symptoms and Possible Causes.....	14
13. Professional Tuning Software ProTuner.....	15
Introduction	15
Software Installation	15
Connections and Testing	19
RS232 Interface Connection	19
Testing the Stepping System	19
Software Introduction.....	20
ProTuner Main Window	20
ProTuner Toolbar.....	20
Option.....	21
Com Config Window	21
Parameters Configuration Window	21
Tuning	22
Anti-Resonance Introduction	26
Internal Pluser(Pulse Generator)	27
Procedure for Achieving Optimum Performance	28
Err_check	29
About.....	30

1. Introduction, Features and Applications

Introduction

The DM442 is a versatility fully digital stepping drive based on a DSP with advanced control algorithm. The DM442 is the next generation of digital stepping motor controls. It brings a unique level of system smoothness, providing optimum torque and nulls mid-range instability. Motor self-test and parameter auto-setup technology offers optimum responses with different motors and easy-to-use. The driven motors can run with much smaller noise, lower heating, smoother movement than most of the drives in the markets. Its unique features make the DM442 an ideal solution for applications that require low-speed smoothness.

Compared to the DM432C, DM442 can output more current. What's more, owing to its higher performance DSP, driven motors can achieve much higher speed (above 3000RPM) than that of the DM432C, offering servo-like performances.

Features

- | Anti-Resonance, provides optimum torque and nulls mid-range instability
- | Motor self-test and parameter auto-setup technology, offers optimum responses with different motors
- | Multi-Stepping allows a low resolution step input to produce a higher microstep output for smooth system performance
- | Microstep resolutions programmable, from full-step to 102,400 steps/rev
- | Supply voltage up to +40 VDC
- | Output current programmable, from 0.5A to 4.2A
- | Pulse input frequency up to 200 KHz
- | TTL compatible and optically isolated input
- | Automatic idle-current reduction (Reduction rate can be software configured)
- | Support PUL/DIR and CW/CCW modes
- | Over-voltage, over-current, phase-error protections

Applications

Suitable for a wide range of stepping motors, from NEMA frame size 17 to 34. It can be used in various kinds of machines, such as laser cutters, laser markers, high precision X-Y tables, labeling machines, and so on. Its unique features make the DM442 an ideal solution for applications that require both low-speed smoothness and high speed performances.

2. Specifications

Electrical Specifications (T_j = 25°C/77°F)

Parameters				Unit
	Min	Typical	Max	
Output current	0.5	-	4.2 (3.0 RMS)	A
Supply voltage	+20	+36	+40	VDC
Logic signal current	7	10	16	mA
Pulse input frequency	0	-	200	kHz
Isolation resistance	500			MΩ

Mechanical Specifications (unit: mm [inch])

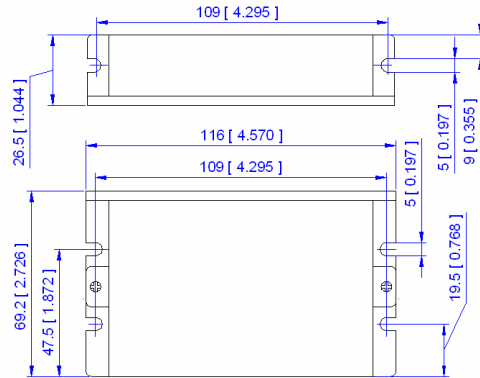

Figure 1: Mechanical specifications

Elimination of Heat

- Drive's reliable working temperature should be <70°C (158°F), and motor working temperature should be <80°C (176°F);
- It is recommended to use automatic idle-current mode, namely current automatically reduce to 60% when motor stops, so as to reduce drive heating and motor heating;
- It is recommended to mount the drive vertically to maximize heat sink area. Use forced cooling method to cool the system if necessary.

Operating Environment and other Specifications

Cooling	Natural Cooling or Forced cooling	
Operating Environment	Environment	Avoid dust, oil fog and corrosive gases
	Ambient Temperature	0°C — 50°C (32°F — 122°F)
	Humidity	40%RH — 90%RH
	Operating Temperature	70°C (158°F) Max
	Vibration	5.9m/s ² Max
Storage Temperature	-20°C — 65°C (-4°F — 149°F)	
Weight	Approx. 200g (7.05oz)	

3. Pin Assignment and Description

The DM442 has two connectors, connector P1 for control signals connections, and connector P2 for power and motor connections. The following tables are brief descriptions of the two connectors. More detailed descriptions of the pins and related issues are presented in section 4, 5, 9.

Connector P1 Configurations

Pin Function	Details
PUL+	Pulse signal: In single pulse (pulse/direction) mode, this input represents pulse signal, each rising or falling edge active (software configurable); 4-5V when PUL-HIGH, 0-0.5V when PUL-LOW. In double pulse mode (pulse/pulse), this input represents clockwise (CW) pulse, active both at high level and low level (software configurable). For reliable response, pulse width should be longer than 2.5μs. Series connect resistors for current-limiting when +12V or +24V used. The same as DIR and ENA signals.
PUL-	
DIR+	DIR signal: In single-pulse mode, this signal has low/high voltage levels, representing two directions of motor rotation; in double-pulse mode (software configurable), this signal is counter-clock (CCW) pulse, active both at high level and low level (software configurable). For reliable motion response, DIR signal should be ahead of PUL signal by 5μs at least. 4-5V when DIR-HIGH, 0-0.5V when DIR-LOW. Please note that rotation direction is also related to motor-drive wiring match. Exchanging the connection of two wires for a coil to the drive will reverse motion direction.
DIR-	
ENA+	Enable signal: This signal is used for enabling/disabling the drive. High level (NPN control signal, PNP and Differential control signals are on the contrary, namely Low level for enabling.) for enabling the drive and low level for disabling the drive. Usually left UNCONNECTED (ENABLED) .
ENA-	

Selecting Active Pulse Edge and Control Signal Mode

The DM442 supports PUL/DIR and CW/CCW modes and pulse actives at rising or falling edge. See more information about these settings in Section 13. Default setting is PUL/DIR mode and rising edge active (NPN, and PNP control signal is on the contrary).

Connector P2 Configurations

Pin Function	Details
+Vdc	Power supply, 20~40 VDC, Including voltage fluctuation and EMF voltage.
GND	Power Ground.
A+, A-	Motor Phase A
B+, B-	Motor Phase B

4. Control Signal Connector (P1) Interface

The DM442 can accept differential and single-ended inputs (including open-collector and PNP output). The DM442 has 3 optically isolated logic inputs which are located on connector P1 to accept line drive control signals. These inputs are isolated to minimize or eliminate electrical noises coupled onto the drive control signals. Recommend use line drive control signals to increase noise immunity of the drive in interference environments. In the following figures, connections to open-collector and PNP signals are illustrated.

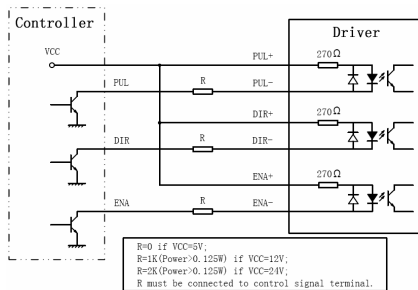

Figure 2: Connections to open-collector signal (common-anode)

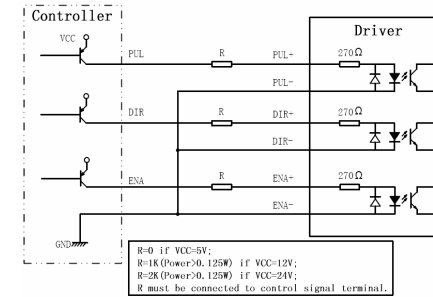

Figure 3: Connection to PNP signal (common-cathode)

5. Connecting the Motor

The DM442 can drive any 2-phase and 4-phase hybrid stepping motors.

Connections to 4-lead Motors

4 lead motors are the least flexible but easiest to wire. Speed and torque will depend on winding inductance. In setting the drive output current, multiply the specified phase current by 1.4 to determine the peak output current.

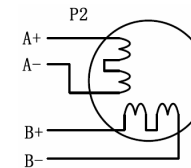

Figure 4: 4-lead Motor Connections

Connections to 6-lead Motors

Like 8 lead stepping motors, 6 lead motors have two configurations available for high speed or high torque operation. The higher speed configuration, or half coil, is so described because it uses one half of the motor's inductor windings. The higher torque configuration, or full coil, uses the full windings of the phases.

Half Coil Configurations

As previously stated, the half coil configuration uses 50% of the motor phase windings. This gives lower inductance, hence, lower torque output. Like the parallel connection of 8 lead motor, the torque output will be more stable at higher speeds. This configuration is also referred to as half chopper. In

setting the drive output current multiply the specified per phase (or unipolar) current rating by 1.4 to determine the peak output current.

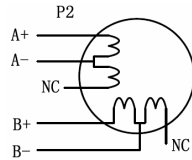

Figure 5: 6-lead motor half coil (higher speed) connections

Full Coil Configurations

The full coil configuration on a six lead motor should be used in applications where higher torque at lower speeds is desired. This configuration is also referred to as full copper. In full coil mode, the motors should be run at only 70% of their rated current to prevent over heating.

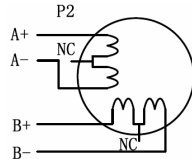

Figure 6: 6-lead motor full coil (higher torque) connections

Connections to 8-lead Motors

8 lead motors offer a high degree of flexibility to the system designer in that they may be connected in series or parallel, thus satisfying a wide range of applications.

Series Connections

A series motor configuration would typically be used in applications where a higher torque at lower speeds is required. Because this configuration has the most inductance, the performance will start to degrade at higher speeds. In series mode, the motors should also be run at only 70% of their rated current to prevent over heating.

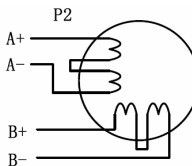

Figure 7: 8-lead motor series connections

Parallel Connections

An 8 lead motor in a parallel configuration offers a more stable, but lower torque at lower speeds. But because of the lower inductance, there will be higher torque at higher speeds. Multiply the per phase (or unipolar) current rating by 1.96, or the bipolar current rating by 1.4, to determine the peak output current.

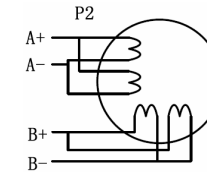

Figure 8: 8-lead motor parallel connections

NEVER disconnect or connect the motor while the power source is energized.

6. Power Supply Selection

The DM442 can match medium and small size stepping motors (from NEMA frame size 14 to 34) made by Leadshine or other motor manufactures around the world. To achieve good driving performances, it is important to select supply voltage and output current properly. Generally speaking, supply voltage determines the high speed performance of the motor, while output current determines the output torque of the driven motor (particularly at lower speed). Higher supply voltage will allow higher motor speed to be achieved, at the price of more noise and heating. If the motion speed requirement is low, it's better to use lower supply voltage to decrease noise, heating and improve reliability.

Regulated or Unregulated Power Supply

Both regulated and unregulated power supplies can be used to supply the drive. However, unregulated power supplies are preferred due to their ability to withstand current surge. If regulated power supplies (such as most switching supplies.) are indeed used, it is important to have large current output rating to avoid problems like current clamp, for example using 4A supply for 3A motor-drive operation. On the other hand, if unregulated supply is used, one may use a power supply of lower current rating than that of motor (typically 50%~70% of motor current). The reason is that the drive draws current from the power supply capacitor of the unregulated supply only during the ON duration of the PWM cycle, but not during the OFF duration. Therefore, the average current withdrawn from power supply is considerably less than motor current. For example, two 3A motors can be well supplied by one power supply of 4A rating.

Multiple Drives

It is recommended to have multiple drives to share one power supply to reduce cost, if the supply has enough capacity. To avoid cross interference, **DO NOT** daisy-chain the power supply input pins of the drives. Instead, please connect them to power supply separately.

Selecting Supply Voltage

The power MOSFETS inside the DM442 can actually operate within +20 ~ +40VDC, including power input fluctuation and back EMF voltage generated by motor coils during motor shaft deceleration. Higher supply voltage can increase motor torque at higher speeds, thus helpful for avoiding losing steps. However, higher voltage may cause bigger motor vibration at lower speed, and it may also cause over-voltage protection or even drive damage. Therefore, it is suggested to choose only sufficiently high supply voltage for intended applications, and it is suggested to use power supplies with theoretical output voltage of +20 ~ +36VDC, leaving room for power fluctuation and back-EMF.

7. Selecting Microstep Resolution and Drive Output Current

Microstep resolutions and output current are programmable, the former can be set from full-step to 102,400 steps/rev and the latter can be set from 0.5A to 4.2A. See more information about **Microstep and Output Current Setting** in Section 13.

However, when it's not in software configured mode, this drive uses an 8-bit DIP switch to set microstep resolution, and motor operating current, as shown below:

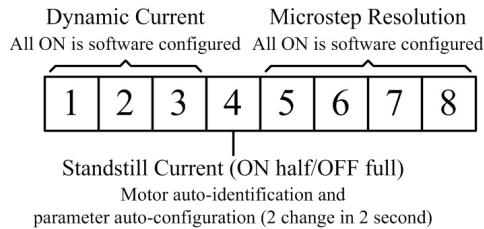

Microstep Resolution Selection

When it's not in software configured mode, microstep resolution is set by SW5, 6, 7, 8 of the DIP switch as shown in the following table:

Microstep	Steps/rev.(for 1.8°motor)	SW5	SW6	SW7	SW8
1 to 512	Default/Software configured	ON	ON	ON	ON
2	400	OFF	ON	ON	ON
4	800	ON	OFF	ON	ON
8	1600	OFF	OFF	ON	ON
16	3200	ON	ON	OFF	ON
32	6400	OFF	ON	OFF	ON
64	12800	ON	OFF	OFF	ON
128	25600	OFF	OFF	OFF	ON
5	1000	ON	ON	ON	OFF
10	2000	OFF	ON	ON	OFF
20	4000	ON	OFF	ON	OFF
25	5000	OFF	OFF	ON	OFF
40	8000	ON	ON	OFF	OFF
50	10000	OFF	ON	OFF	OFF
100	20000	ON	OFF	OFF	OFF
125	25000	OFF	OFF	OFF	OFF

Current Settings

For a given motor, higher drive current will make the motor to output more torque, but at the same time causes more heating in the motor and drive. Therefore, output current is generally set to be such that the motor will not overheat for long time operation. Since parallel and serial connections of motor coils will significantly change resulting inductance and resistance, it is therefore important to set drive output current depending on motor phase current, motor leads and connection methods. Phase current rating supplied by motor manufacturer is important in selecting drive current, however the selection also depends on leads and connections.

When it's not in software configured mode, the first three bits (SW1, 2, 3) of the DIP switch are used to set the dynamic current. Select a setting closest to your motor's required current.

Dynamic current setting

Peak Current	RMS Current	SW1	SW2	SW3
Default/Software configured (0.5 to 4.2A)		ON	ON	ON
1.46A	1.04A	OFF	ON	ON
1.91A	1.36A	ON	OFF	ON
2.37A	1.69A	OFF	OFF	ON
2.84A	2.03A	ON	ON	OFF
3.31A	2.36A	OFF	ON	OFF
3.76A	2.69A	ON	OFF	OFF
4.20A	3.00A	OFF	OFF	OFF

Notes: Due to motor inductance, the actual current in the coil may be smaller than the dynamic current setting, particularly under high speed condition.

Standstill current setting

SW4 is used for this purpose. OFF meaning that the standstill current is software configured, and ON meaning that standstill current is set to be the same as the selected dynamic current.

By default, the current automatically reduced to 60% of the selected dynamic current two second after the last pulse. Theoretically, this will reduce motor heating to 36% (due to $P=I^2 \cdot R$) of the original value. **Reduction rate and idle time can be configured in the PC software ProTuner.** See more information in section 13.

8. Wiring Notes

- In order to improve anti-interference performance of the drive, it is recommended to use twisted pair shield cable.
- To prevent noise incurred in PUL/DIR signal, pulse/direction signal wires and motor wires should not be tied up together. It is better to separate them by at least 10 cm, otherwise the disturbing signals generated by motor will easily disturb pulse direction signals, causing motor position error, system instability and other failures.
- If a power supply serves several drives, separately connecting the drives is recommended instead of daisy-chaining.
- It is prohibited to pull and plug connector P2 while the drive is powered ON, because there is

high current flowing through motor coils (even when motor is at standstill). Pulling or plugging connector P2 with power on will cause extremely high back-EMF voltage surge, which may damage the drive.

9. Typical Connection

A complete stepping system should include stepping motor, stepping drive, power supply and controller (pulse generator). A typical connection is shown as figure 9.

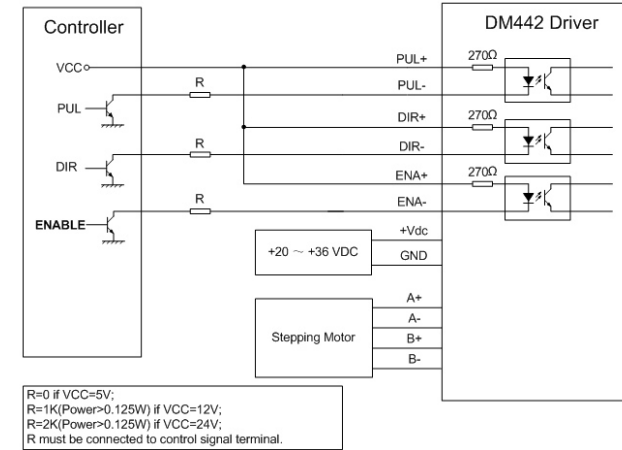

Figure 9: Typical connection

10. Sequence Chart of Control Signals

In order to avoid some fault operations and deviations, PUL, DIR and ENA should abide by some rules, shown as following diagram:

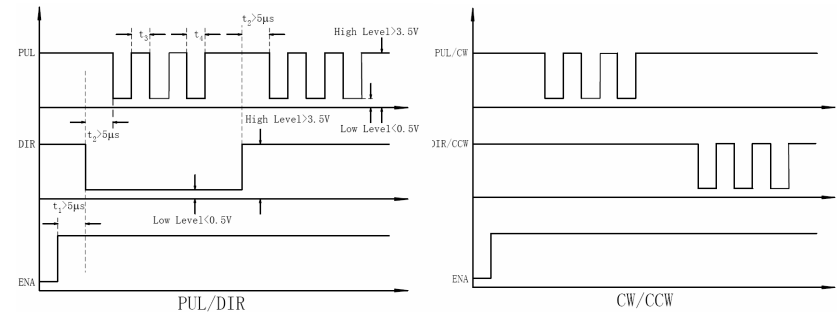

Figure 10: Sequence chart of control signals

Remark:

- a) t1: ENA must be ahead of DIR by at least 5μs. Usually, ENA+ and ENA- are NC (not connected). See “Connector P1 Configurations” for more information.
- b) t2: DIR must be ahead of PUL active edge by 5μs to ensure correct direction;
- c) t3: Pulse width not less than 2.5μs;
- d) t4: Low level width not less than 2.5μs.

11. Protection Functions

To improve reliability, the drive incorporates some built-in protection functions. The DM442 uses one RED LED to indicate what protection has been activated. The periodic time of RED is 5 s (seconds), and how many times the RED turns on indicates what protection has been activated. Because only one protection can be displayed by RED LED, so the drive will decide what error to display according to their priorities. See the following **Protection Indications** table for displaying priorities.

Over-current Protection

Over-current protection will be activated when continuous current exceeds the limit or in case of short circuit between motor coils or between motor coil and ground, and RED LED will turn on once within each periodic time (5 s).

Over-voltage Protection



When power supply voltage exceeds 50±1 VDC, protection will be activated and RED LED will turn on twice within each periodic time (5 s).

Phase Error Protection

Motor power lines wrong & not connected will activate this protection. RED LED will turn on four times within each periodic time (5 s).

Attention: When above protections are active, the motor shaft will be free or the LED will blink. Reset the drive by repowering it to make it function properly after removing above problems. Since there is no protection against power leads (+, -) reversal, it is critical to make sure that power supply leads correctly connected to drive. Otherwise, the drive will be damaged instantly.

Protection Indications

Priority	Time(s) of ON	Sequence wave of RED LED	Description
1 st	1		Over-current protection
2 nd	2		Over-voltage protection
3 rd	4		Phase error protection

12. Frequently Asked Questions

In the event that your drive doesn't operate properly, the first step is to identify whether the problem is electrical or mechanical in nature. The next step is to isolate the system component that is causing the problem. As part of this process you may have to disconnect the individual components that make up your system and verify that they operate independently. It is important to document each step in the troubleshooting process. You may need this documentation to refer back to at a later date, and these details will greatly assist our Technical Support staff in determining the problem should you need assistance.

Many of the problems that affect motion control systems can be traced to electrical noise, controller software errors, or mistake in wiring.

Problem Symptoms and Possible Causes

Symptoms	Possible Problems
Motor is not rotating	No power
	Microstep resolution setting is wrong
	DIP switch current setting is wrong
	Fault condition exists
	The drive is disabled
Motor rotates in the wrong direction	Motor phases may be connected in reverse
The drive in fault	DIP switch current setting is wrong
	Something wrong with motor coil
Erratic motor motion	Control signal is too weak
	Control signal is interfered
	Wrong motor connection
	Something wrong with motor coil
	Current setting is too small, losing steps
Motor stalls during acceleration	Current setting is too small
	Motor is undersized for the application
	Acceleration is set too high
	Power supply voltage too low
Excessive motor and drive heating	Inadequate heat sinking / cooling
	Automatic current reduction function not being utilized
	Current is set too high

13. Professional Tuning Software ProTuner

Introduction

This section will provide an overview of connection and basic setup instructions for Leadshine’s digital stepping drive DM442 using the **ProTuner** software. These instructions will walk you through the following steps necessary to start up your drive and motor. This section is intended for setting up the drive with the **ProTuner**.

Software Installation

The **ProTuner** is windows based setup software for tuning Leadshine’s digital stepper drive DM442. It can run in windows systems, including Win95/Win98/WindowsNT/ Windows 2000/Windows XP. And the selected PC should have 1 serial port at least for communicating with the drive.

Double click “**ProTuner_DM442_V2.0.exe**” to begin installing the **ProTuner**. See Figure 11. Click **Next** to enter the “License Agreement” window. See Figure 12.

Note: The user can get it from either Leadshine CD or website. Please get the latest version from <http://www.leadshine.com>.



Figure 11: Begin to install the ProTuner

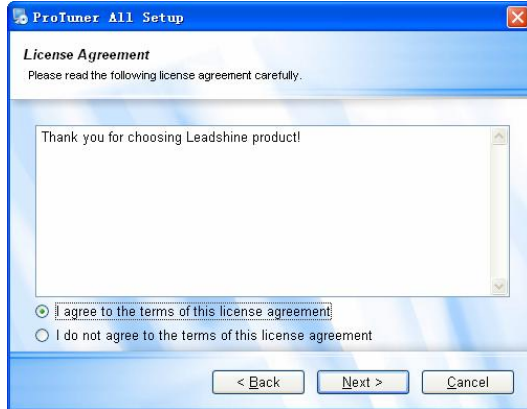

Figure 12: License agreement

Choose “I agree to the terms of this license agreement” and click **Next** to continue installation. The user can enter user’s information in the following window. See Figure 13. After entering the user’s information, click **Next** to select installation folder, where you would like to install the **ProTuner**. See Figure 14.

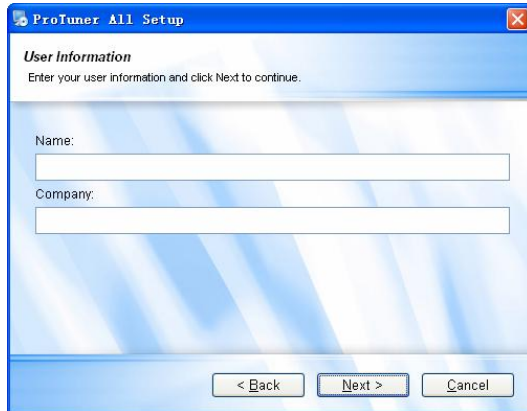

Figure 13: User’s information settings

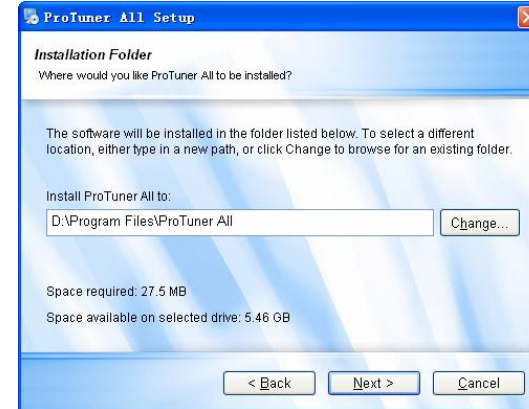

Figure 14: Installation folder settings

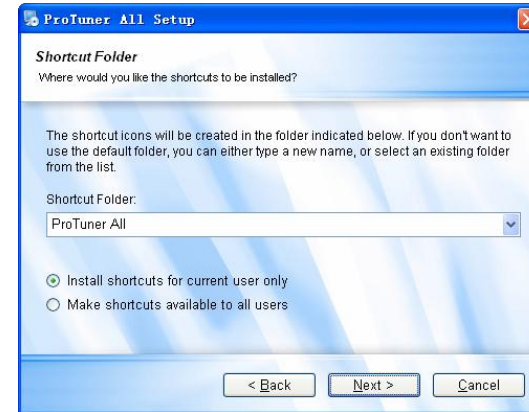

Figure 15: Shortcut folder setting

Set the “Shortcut Folder” in Figure 15 and continue to install the **ProTuner** by following Figure 16 and Figure 17. An **Installation Successful** window will appear if the **ProTuner** is installed successfully. See Figure 18.



Figure 16: Installation information summarization

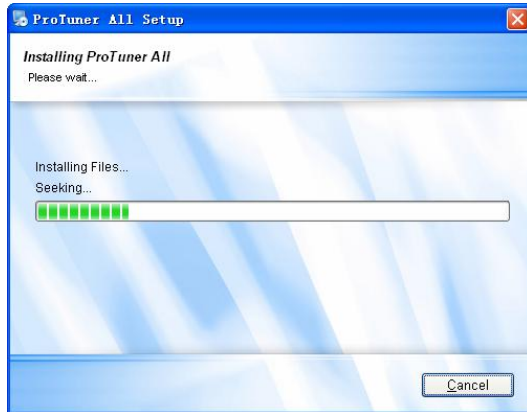

Figure 17: Installing the ProTuner



Figure 18: Finish installation

Connections and Testing

Connect the stepping system according to the contents in previous sections and connect the PC to the drive as the following figure.

RS232 Interface Connection

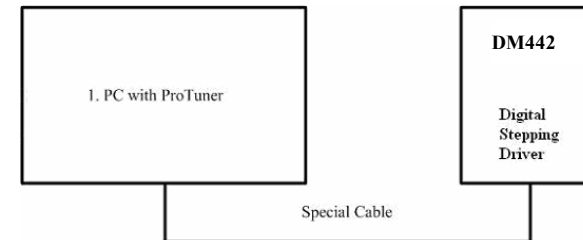

Figure 19: RS232 interface connection

Testing the Stepping System

Turn on the power supply, the green (Power) LED will light. The DM442 has default parameters stored in the drive. If the system has no hardware and wirings problem, the motor should be locked and the drive should be ready.

If the red LED immediately turns on (flickers), then check power supply, the motor, motor wirings

and try again. Open the tuning software **ProTuner** and check drive status by clicking **Err_check**. If it's **Phase Error**, check the motor, motor wirings and try again.

If the RED LED is OFF and the motor is normal, then you can start to tune the servo with **ProTuner**.

However, we recommend you see the following contents before starting tuning.

Software Introduction

ProTuner Main Window



Figure 20: ProTuner

ProTuner Toolbar

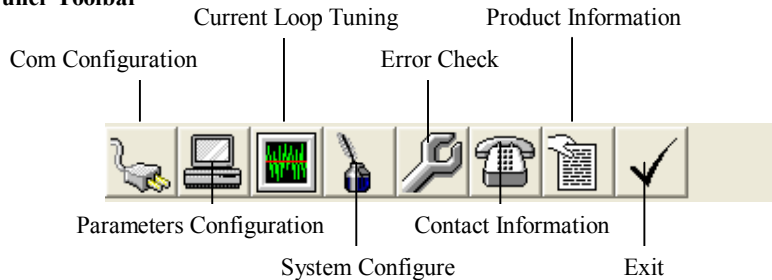

Option

The user can choose three drop-down menus by clicking “**Option**”, including **Com Configuration**, **Parameters Configuration**, and **Exit**.

- I **Com Configuration**: Configure Com communication interface.
- I **Parameteres Configuration**: Read/write parameters between the drive and the ProTuner, or save configuration as a file and load configuration from a file.
- I **Exit**: Exit the **ProTuner**.

Com Config Window



Figure 21: RS232 communication configuration window

Serial Port: Select the serial communication port to which the drive is connected. The factory default setting is COM1.

Baud Rate: Select the communication baud rate. The factory default setting is 38400.

Click **Open** button to establish a connection with the specified settings. When connecting, you can read stored parameter setting from the drive to the ProTuner, or write new parameter setting from the ProTuner to the drive settings in the **parameters configuration** window.

Parameters Configuration Window

Recommend to always keep this window active. In this window, the user can read the parameter setting from the drive, or write parameters setting to the drive after finishing to configure all the settings. In addition, the user can also save the configuration to a file for later use or load a

configuration from a stored file. See figure 22.

Read RAM: Read parameter settings from the drive’s RAM to the ProTuner.

Write RAM: Write parameter settings from the ProTuner to the drive’s RAM.

Write EEprom: Write parameter settings from the ProTuner to the drive’s EEprom.

Reset Drive: Reset all parameter to default value.

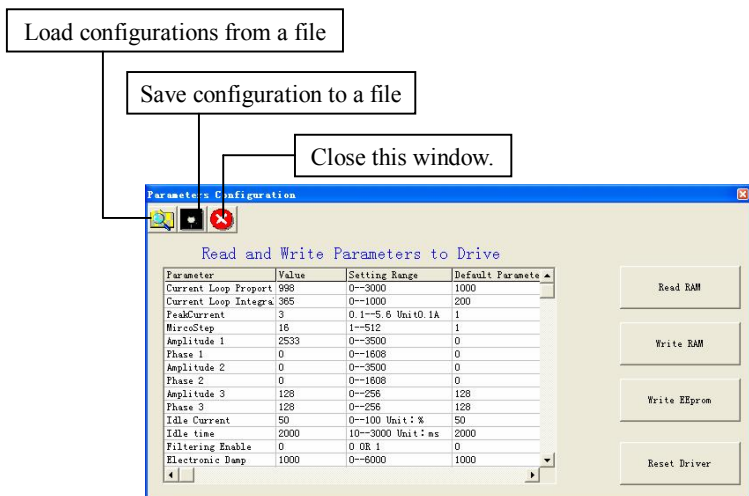

Figure 22: Parameters configuration window

Tuning

The user can choose one or two drop-down menu(s) by clicking **Tuning**, including **CurrentLoop** and **SystemConfig**.

I CurrentLoop: In Current Tuning window, the user can tune the **Kp (Proportional Gain)** and **Ki (Integral Gain)** of drive’s current loop to optimize responses with different motors. Start/Restart a Step Response test to get an optimum response.

Kp: Proportional Gain. Proportional Gain determines the response of the drive to current setting command. Low Proportional Gain provides a stable system (doesn’t oscillate), has low stiffness, and

large current error, causing poor performances in tracking current setting command in each step like Figure 23. Too large Proportional Gain values will cause oscillations and unstable systems.



Figure 23: Current Tuning window

Ki: Integral Gain. Integral Gain helps the drive to overcome static current errors. A low or zero value for the Integral Gain may have current errors at rest. Increasing the Integral Gain can reduce the error. If the Integral Gain is too large, the systems may “hunt” (oscillate) about the desired position.

Start button: The user can start a Step Response test by clicking this button. Start/Restart a Step Response test to get an optimum response like Figure 23, and remember to save the settings to the drive by clicking **Write EEprom** in **parameters configuration** window when finish tuning .

Auto button: Click this button to auto-configure Kp and Ki for the connected motor. It has the same effect as changing SW4 two times in one second.

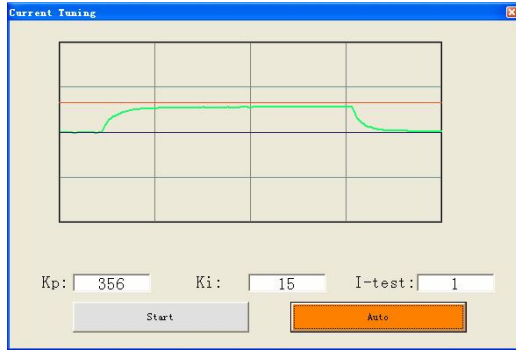

Figure 24: Kp=356, Ki=15 (poor performances)

Notes:

However, if the user does not want to tune the current loop after changing a different stepping motor, then **Motor self-test and parameter auto-setup** technology of the DM442 can replace manual tuning the drive with **ProTuner**. Just changes SW4 two times in 1 second (without ProTuner), or click **Auto** button, and then the drive will auto-identify the new motor and auto-configure related control parameters for optimum responses. **Recommend** use this function after changing the driven motor.

I SystemConfig:

In **SystemConfig** window, the user can configure Peak Current, Microstep, Elec Damp, Idle Current, Idle Time, Command Type, Active Edge and eliminate motor resonance. A built-in pulse generator can be used for test during tuning. See Picture 25.

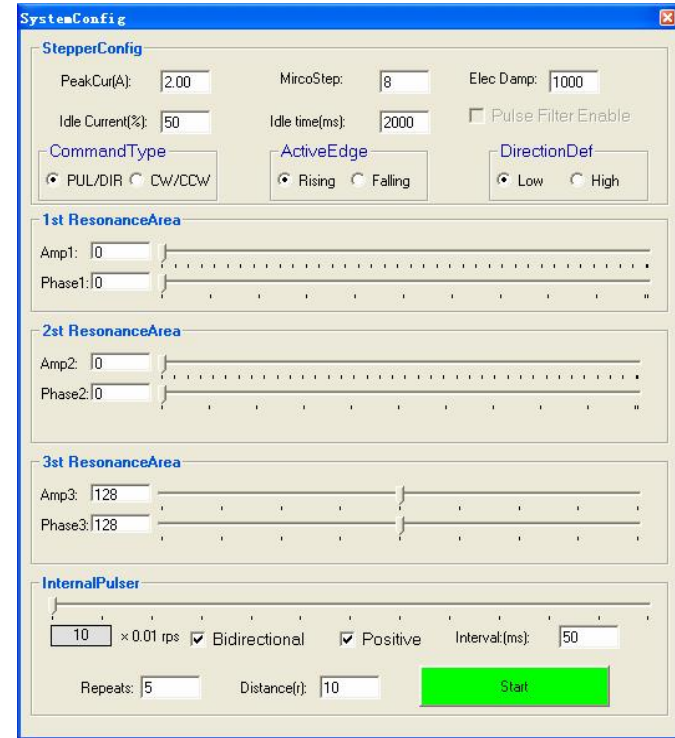

Figure 25: System Configure Window

PeakCur: Peak Current. The value is the peak current to the selected motor and can be set from 0.1 to 4.2 A. The user can set the peak current with **ProTuner** or DIP switches, see more information about setting output current of the drive in section 5 “**Connecting the Motor**” and section 7 “**Selecting Microstep Resolution and Drive Output Current**”.

MicroStep: Microstep Resolution. The value is drive’s microstep resolution setting and can be set from 1 to 512. The user can set the microstep with **ProTuner** or DIP switches, See more information about setting output current of the drive in section 7 “**Selecting Microstep Resolution and Drive Output Current**”.

ElecDamp: Electronic Damping Coefficient. The electronic damping restrain resonance of the system and prevent amplitude of the oscillation from increasing to the extend that it makes the motor

out of control. The optimal value depends on the system, and the default value is 3000.

Idle Current: Standstill Current when motor stop. When the motor stop time exceeds the **Idle Time**, the motor coil current reduces to Idle Current (In percentage). The percentage is rated to the Peak Current.

Idle Time: See **Idle Current**.

Pulse Filter Enable: Click the check box will turn on the internal pulse smoother or filter of DM442.

DirectionDef: Direction Definition. Relate the default running direction to a **HIGH** level input in DIR or **Low** level input in DIR. This panel is used for PUL/DIR command type only. Please note that the default direction is also related to motor coil connections.

CommandType: Command Type of control signal, including PUL/DIR and CW/CCW. Set this parameter according to **Command Type** of motion controller.

ActiveEdge: Active Edge. The user can set the triggered edge of pulse command signal in this panel. When the drive works in CW/CCW mode, no matter what level is at fixed level terminal, the drive can work properly.

Anti-Resonance Introduction

Step motors are highly resonant, which results in vibration and ringing. The ringing utilizes a large fraction of the motor's available torque – thereby wasting performance. Furthermore, at mid-range velocities, the resonance can become so severe that the motor loses synchronization and stalls. The DM442 drive provides robust anti-resonance control to stop the vibrations and maintain equilibrium. This feature requires that the drive be configured with respect to the total inertia in the system. If set improperly, the effectiveness of the feature may be diminished.

The user can invoke or disable the feature by setting **Amp** and **Phase** values in **SystemConfig** window. **Amp** and **Phase** values all zero is to disable the feature, otherwise is to invoke the feature. It should be enabled unless the system configuration either does not need it or cannot tolerate it. A system with loose couplings or viscous loading generally does not need this feature. If a system has compliant (springy) coupling and is absent appreciably viscosity, it may not respond well to the active,

anti-resonant loop in the drive. The anti-resonant feature is not designed to damp such a 4th order system. If the application of anti-resonance results in degradation or instability, it should be disabled.

1st ResonanceArea: Parameters for 1st resonance area. It is usually between 0.6rps and 1.2rps.

Amp1 is Amplitude adjustment for 1st resonance area.

Phase1 is Phase adjustment for 1st resonance area. The user can enter a value directly in the text box or move the slider bar back and forth to get an optimum value.

2nd ResonanceArea: Parameters for 2nd resonance area. It is usually between 1.2rps and 2.4rps. Default **Amp2** and **Phase2** values are zero.

3rd ResonanceArea: Parameters for 3rd resonance area. It is usually between 2.4rps and 4.8rps. Default **Amp3** and **Phase3** values are 128.

Internal Pluser(Pulse Generator)

The internal pulse generator offers a simple motion control for self-test and anti-resonance tuning. The user can adjust moving velocity, configure the direction and repeats of the motion.

Bidirectional: Click the check box to make the motion be bidirectional. Otherwise the motor only run in one direction.

Positive: It is used to change the initial direction for the motion.

Interval: Stop time before the next motion repeat. Unit: ms.

Repeats: Motion repeat times. If it is bidirectional, one repeat is moving forward then back.

Distance: Moving distance in one direction in revolution.

Start/Stop: Start/Stop the motion.

Note:

When you adjust the velocity by moving the slider forth and back, the motor velocity would not change immediately as you expected. That is because the drive only read the new speed when it changes direction. Also be careful about the initial direction and moving distance if the motor is

installed on a machine. It is recommended that set low speed and small distance if you are not sure whether the direction and distance is correct or not.

Procedure for Achieving Optimum Performance

Step 1: Start the motion test by clicking **Start/Stop** button. Find a resonance speed by slightly moving the slider bar of internal pulse generator back and forth. You can also use the arrow keys to adjust the speed precisely.

Step 2: Run the motor at the resonance speed and verify the motor smoothness. You may find a better smoothing value by slightly moving the slider bars of **AMP(s)** and **Phase(s)** back and forth.

It is very important to make the **AMP(s)** and **Phase(s)** adjustments at the proper test speeds with an unloaded motor. Running at an incorrect test speed will not excite the motor at its peak resonance, making it more difficult to find proper adjustment values. Optimum **AMP(s)** and **Phase(s)** values may be a little different between running the tests with an unloaded motor and a load motor.

For example, we find a resonance speed at 0.98 rps. We begin to move the Amp1 slider forth and the motor vibration and noise became lower and lower. Finally we find the move is the smoothest when **Amp 1** is 3300. The motor vibration and noise increase if **Amp 1** exceeds 3300. Then we follow the same procedure to search the best point for **Phase 1**. See Figure 26. Anti-resonance tuning is done.

Please remember to click **Write EEprom** to write the final parameter settings to the drive when finish tuning.

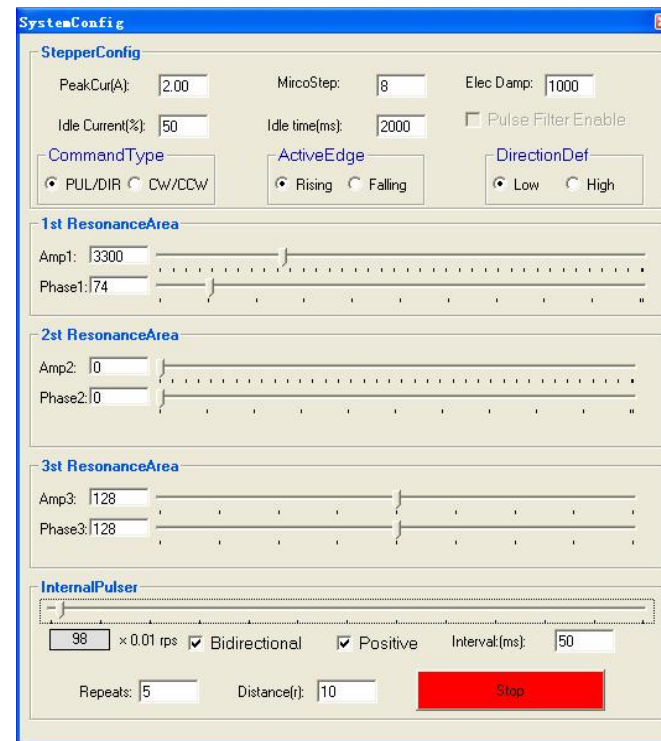

Figure 26: 1st Anti -Resonance Tuning (Speed=0.98rps)

Err_check

I Error Check: This window shows both the present status of each error event and their history. Current error event(s) can be reset by clicking **Erase Current Err!** button, and all error events can be reset by clicking **Erase All!** button. List of the last ten drive faults. #0 being the most recent, #9 is the oldest. See Figure 27.

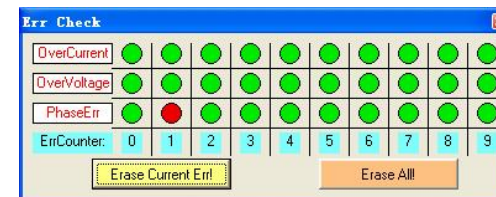

Figure 27: Error check window

OverCurrent: Over-current Protection. Protection will be activated when continuous current exceeds 16A.

OverVoltage: Over-voltage Protection. When power supply voltage exceeds 42 ± 1 VDC, protection will be activated.

PhaseErr: Phase Error Protection. Motor power lines wrong & not connected will activate this protection.

ErrCounter: Displays current error(s) and current error history.

Erase Current Err!: Erase Current Err button. The user can clear current error(s) by clicking this button.

Erase All!: Erase All! button. The user can clear all error(s) including error history by clicking this button.

About

The user can choose two drop-down menus by clicking “About”, including **Product Information** and **Contact Us**.

l **Product Information** window: Shows some product information about ProTuner.

l **Contact Us** window: Shows some contact information about Leadshine.



Figure 28: Product information



Figure 29: Contact information